

Polyframe. Making things simple.

Now you're talking.

 Part of the
Customade Group

 **POLYFRAME**

3 SASH STYLES IN 1 SYSTEM

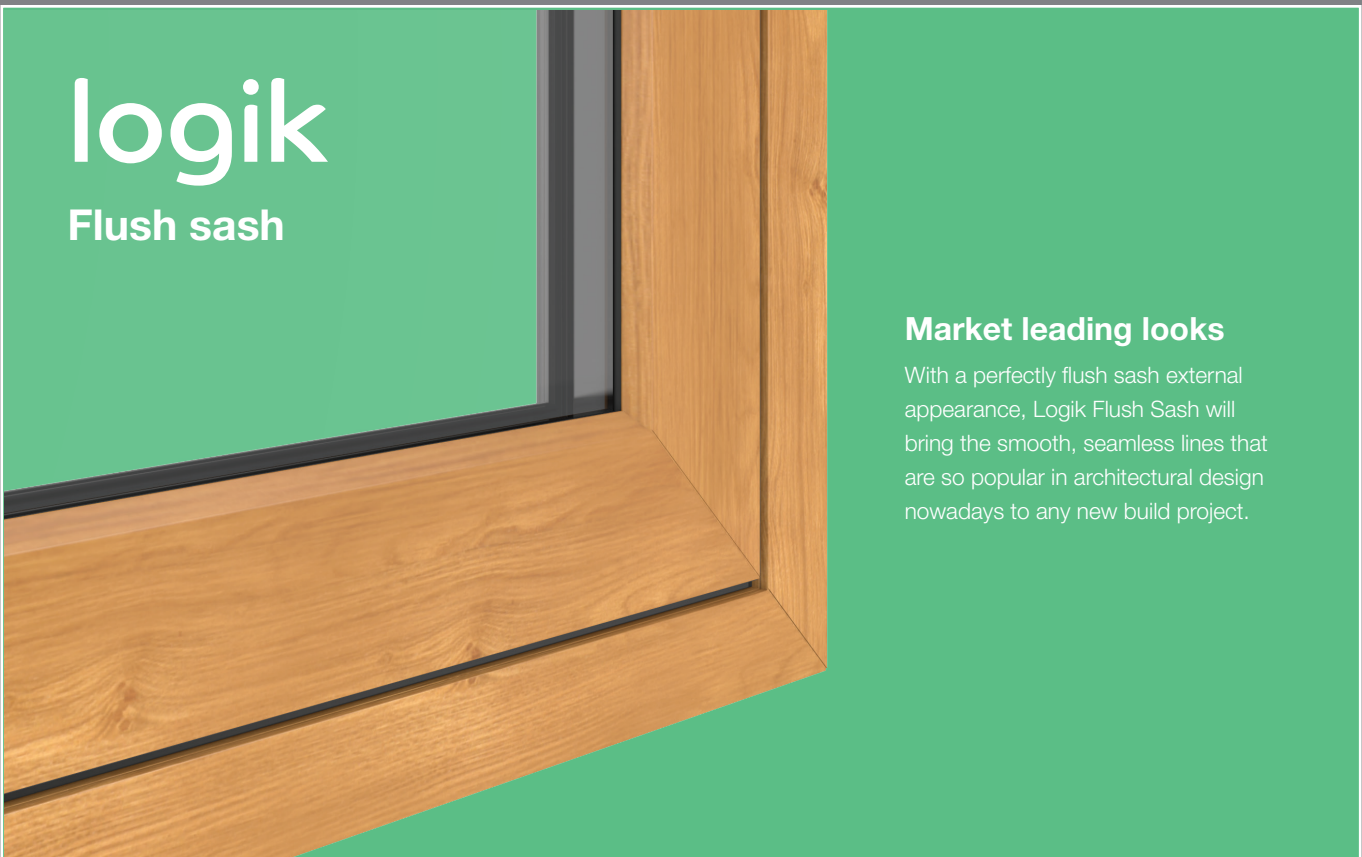
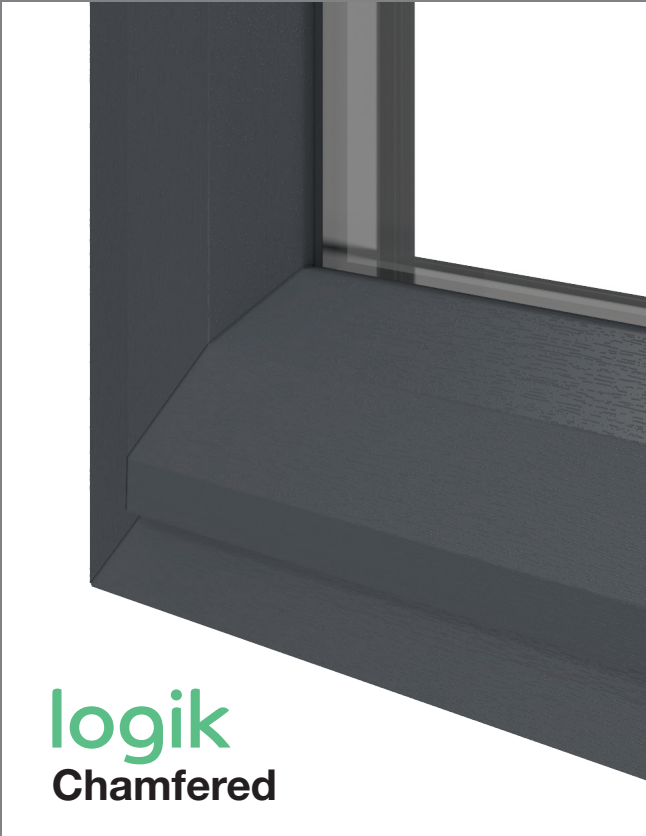

A GREY REVOLUTION



The outstanding feature that makes Logik so special, is its grey substrate option.

With a through-colour grey frame instead of just a surface foil, there's no sign of a white PVC-U core, even when you open the window.

It may seem like a small detail, but the all-grey look is a big thing with homeowners right now and many people are more than ready to pay a premium for it in PVC-U rather than choose the much more expensive aluminium option.

So make sure you're ready to supply everything they're looking for with new Logik Flush Sash to complement the Logik suite.

GREY SUBSTRATE OPTION FOR THE CONSISTENT LOOK

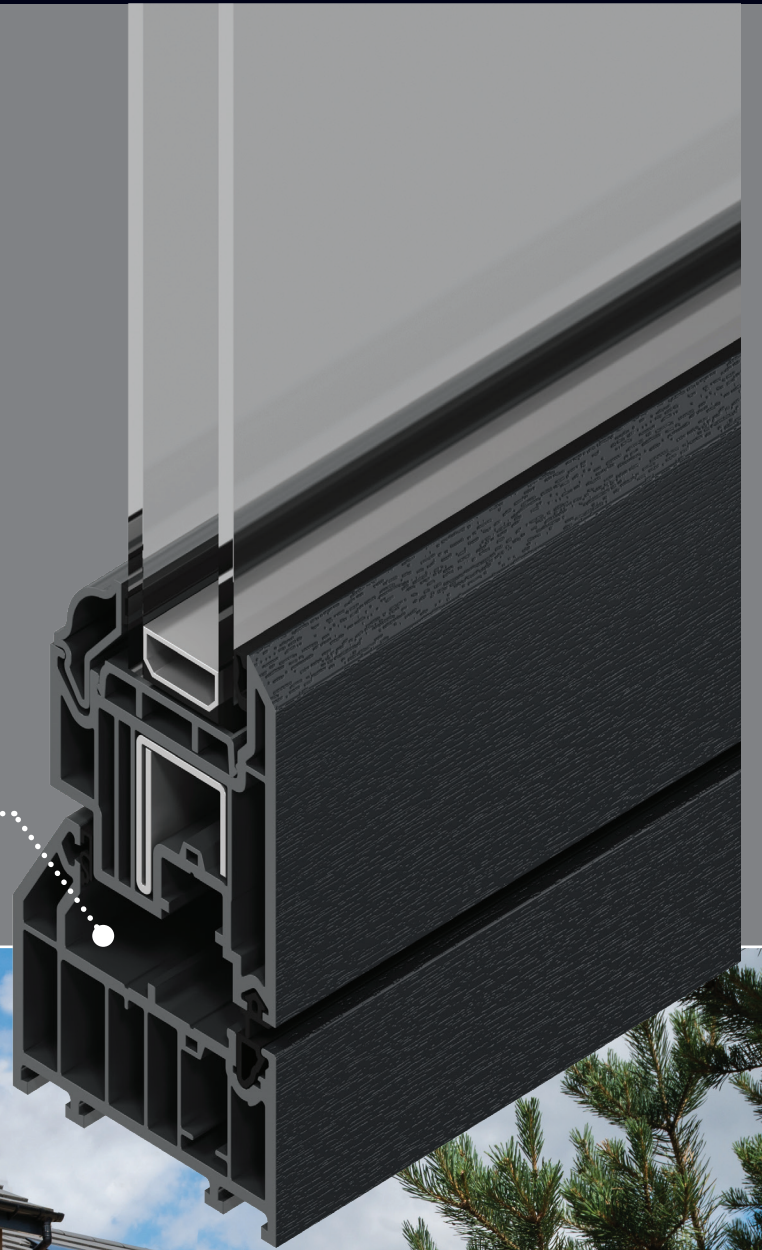

Logik Chamfered in Slate Grey



logik

A PROFILE SYSTEM DESIGNED FOR ENHANCED AESTHETICS AND EASE OF FABRICATION

The Logik profile system from Eurocell combines leading energy efficiency performance and aesthetics with ease of use – for the ultimate system

The Logik profile system combines leading energy efficiency performance and aesthetics with ease of use, for the ultimate system. Logik is specially designed for ease and speed of fabrication and fitting, featuring a unique, patented knock-in bead system. Ideally suited for new build or replacement windows, its 70mm front-to-back dimension enables the seamless replacement of timber frames.

Logik is designed for improved aesthetics and clean sight lines, with its unobtrusive gasket line and slim profile. The profile features multiple chambers to enhance thermal

efficiency and strength, and improve drainage. Available with chamfered or sculptured ovolo styles in a range of colours, Logik window profiles add a touch of distinction to any home.

The sustainable option

Logik features post-consumer recycled PVC-U in the central core of the profile with virgin PVC-U on seen faces. This ensures the same aesthetics and technical performance but with more environmentally responsible benefits for today's discerning customers. It offers the same benefits but with more sustainability – at no extra cost to you.

WHY CHOOSE LOGIK?

eurocell



Outstanding technical performance



Fast, accurate fabrication and installation

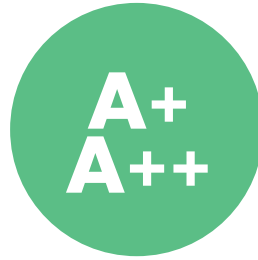

Superb energy efficiency performance



U-values as low as 0.8*



BBA certified system



Market-leading sustainability



Wide range of colour and style options



10 year guarantee for peace of mind

Leading energy efficiency

Maximising the thermal performance of windows is vital to meet rising regulatory and customer demands. The advanced multi-chambered design of the main Logik profiles and innovative PVC-U Thermal Inserts work together to lock in heat. This means Eurocell's 'A+'-rated windows offer market-leading double-glazed unit performance and value.

Exceptional air tightness and weathering performance

The post co-extruded (PCE) gaskets on Logik profiles use a specially developed compound and twin-leg profile connection system with one-way support arm. This provides excellent adhesion to the main profiles. Tested to BS6375, the gasket system achieves outstanding air tightness and weathering performance, improving energy efficiency further by minimising air leakage.

logik products available

STANDARD CASEMENT WINDOWS

FLUSH CASEMENT WINDOWS

TILT AND TURN WINDOWS

FRENCH WINDOWS

RESIDENTIAL DOORS

FRENCH DOORS

*Lower U-values are achievable with Krypton gas.

ADVANCED PERFORMANCE

LEADING TECHNICAL & SUSTAINABILITY PERFORMANCE

3 SASH OPTIONS IN ONE FOR A VERSATILE SYSTEM

GREY SUBSTRATE OPTION FOR THE CONSISTENT LOOK

Enhanced aesthetics for a brighter outlook...

Not only does the innovative six-chambered outer frame option perform better than standard 70mm window profiles, it looks better too. Slimmer than standard systems, it gives any window a sleek, contemporary appearance, increasing the area of glass for improved sight lines and brighter interiors.

A++ performance

A+ Window Energy Ratings (WER) are achievable with Logik – offering market-leading window performance using argon gas. Logik is capable of an A+13 rating (double-glazed) and an A++20 rating (triple-glazed). What's more, U-values as low as 1.2 can be achieved with a double-glazed unit and 0.8 with a triple-glazed unit.

PVC-U Thermal Inserts

PVC-U Thermal Inserts for Logik profiles are the sustainable way to improve your window energy efficiency. The multi-chambered design delivers significantly improved thermal performance, more efficient fabrication and 20% lighter in weight than windows with conventional steel reinforcements.

Quality controlled manufacturing

Quality is carefully controlled and monitored throughout the manufacturing process of the Logik profile system. Eurocell have their own toolmaking and laminating facilities and manufacture in their PVC-U compound mixing plant. Giving them full control over product quality and consistency – right from the start.

High-performance products

Exposed to the elements, windows need to be hard-wearing, weather resistant and long lasting. The Logik window system will enable you to meet and exceed all of these requirements.

Up to 10 year guarantee

Logik profiles are guaranteed for ten years against warping, cracking and discolouration. That means you can give your customers the assurance of a robust, well-designed, precision-made product that's built to last.



eurocell

DOUBLE OR TRIPLE
GLAZING OPTIONS

REINFORCEMENT
OPTIONS

THERMALLY EFFICIENT DESIGN
MULTI-CHAMBERED PROFILES
OR THERMAL INSERTS

MARKET-LEADING FEATURES

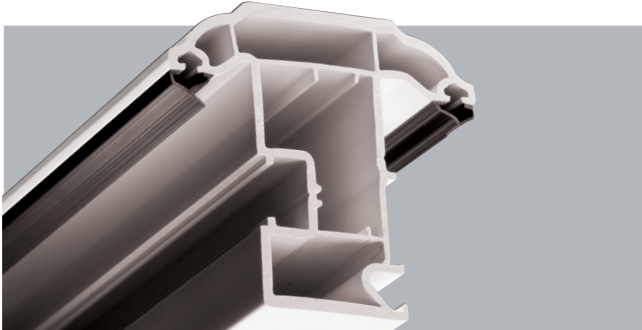

Full depth eurogroove for
maximum hardware compatibility



Soft line bevel feature is matched by the bead

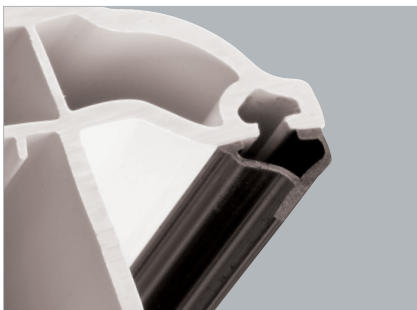

PCE gaskets offer market leading
adhesion, air tightness and weather
performance

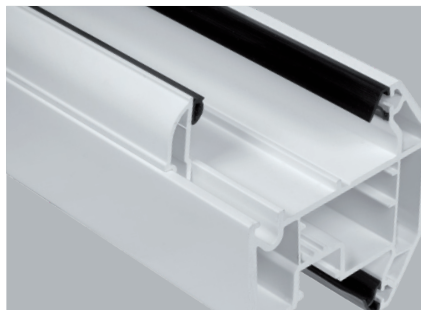

Unique patented knock-in
bead system available with 28mm
and 36mm putty line



Assessment
report number
14/5154

LOGIK WINDOW & DOOR SYSTEM

STYLE & COLOUR OPTIONS



STANDARD CASEMENT WINDOWS
Shown in Ovolo, Cream



FRENCH DOORS
Shown in White



RESIDENTIAL DOORS
Shown in Golden Oak



TILT & TURN WINDOWS
Shown in White



FLUSH CASEMENT WINDOWS
Shown in Irish Oak on White

Up to 10 year guarantee

Logik windows and doors are guaranteed for ten years, so you can give your customers the assurance of a robust, well-designed, precision-made product that's built to last – manufactured by the UK's leading PVC-U specialist.

FRAME COLOURS FROM STOCK



WHITE
White interior



CREAM WHITE†
White interior



WHITE ASH†
White Ash interior



AGATE GREY*
White interior



ANTHRACITE GREY
White interior



ANTHRACITE GREY*
Grey interior



ANTHRACITE GREY SMOOTH FOIL*
White interior



SLATE GREY SMOOTH FOIL*
White interior

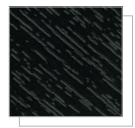

BLACK ASH*
White interior



IRISH OAK†
White interior



IRISH OAK†
Irish Oak interior

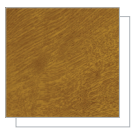

GOLDEN OAK
White interior

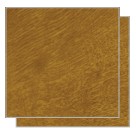

GOLDEN OAK
Golden Oak interior



ROSEWOOD
White interior



ROSEWOOD
Rosewood interior



CHARTWELL GREEN†
White interior

ADDITIONAL COLOUR - on extended lead times



ANTHRACITE GREY SMOOTH FOIL*
Grey interior

†Ovolo only *Chamfered only

SYNCRO PATIO DOOR SYSTEM

eurocell



syncro

THE ALL NEW PATIO DOOR SYSTEM
FROM EUROCELL

Eurocell leads the way in patio doors. In fact, they have long been the customer's choice when it comes to performance with style.

Close to perfection in the patio door market

- More sustainable with frame composition made up of at least 40% PCW (post-consumer waste)
- Better thermal efficiency with U-values as low as 1.3 for double glazed units and 1.0 for triple glazed
- Maximum width of 3.5m (2 pane)
- Triple as well as double glazing compatible for even better insulation
- Grey substrate for total coordination with modern designs.



MAXIMUM ENERGY EFFICIENCY

FOR MINIMUM OUTLAY ON HEATING BILLS

Increasing demand for energy efficient windows

Delivering superior energy efficiency has never been more important for the construction industry and homeowners. It's an alarming fact that our homes and buildings are responsible for almost half of the UK's carbon dioxide emissions.

Windows have an important role to play in combating energy wastage, since 20% of the heat escaping from an average home is lost through its windows*.

The green option you can afford

Eurocell Logik helps builders and homeowners to meet their environmental objectives - without having to pay a premium for going green. Fitting Eurocell PVC-U Thermal Inserts in Logik profiles to boost the thermal efficiency of your windows provides better value than steel alternatives. And they are made from 100% recycled material.

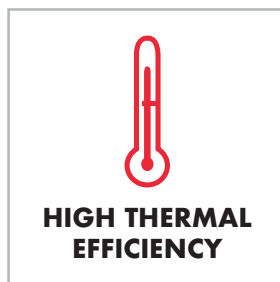
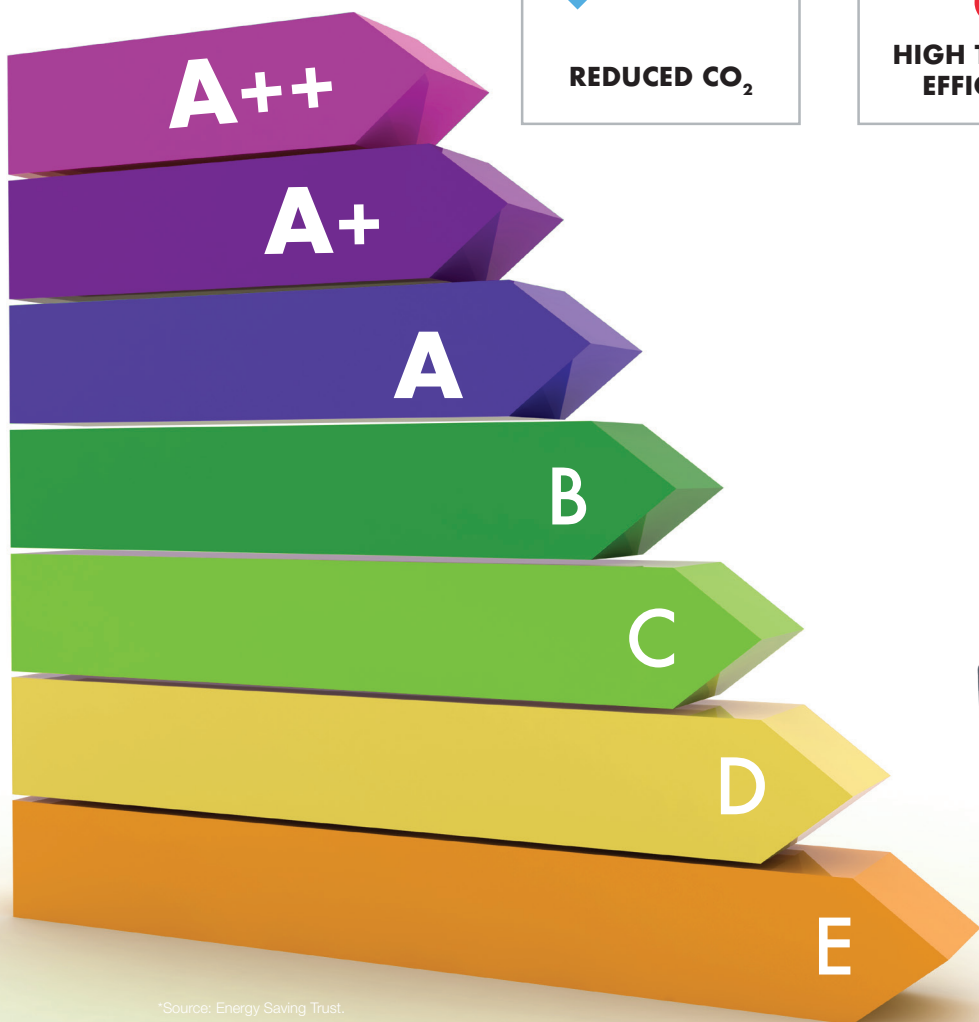

*Source: Energy Saving Trust.

INTRODUCING THE LOGIK FLUSH SASH

eurocell

logik **Flush Sash** Business has never looked better.

Logik has been a favourite for many years now. With all the advantages it offers over other systems, it's no wonder. From game changing features like its unique knock-in bead system to the single steel reinforcement bars that make it a byword for strength and security, Logik is the name people look for in the trade.

A perfect addition to the range

Eurocell has added to the range with a third frame style to the Chamfered and Ovolo ranges - the Logik Flush Sash. With a modern new look in a range of on-trend colours – including through-colour grey – offer your style conscious customers more.

Colours to frame the view

Like the rest of the Logik range, an extensive choice of woodgrain foils gives Logik Flush Sash a real wood look that stands up to all but the closest of inspections. Have the look of genuine timber frame with all the energy efficiency and low maintenance benefits of PVC-U.

Or in grey deliver an architectural design feel. It's the perfect replacement window for adding contemporary kerb appeal to older homes or retaining character in older properties.



HARDWARE & LOCKS

From tri-clad finishes to multi-lock handles, beautiful windows and doors call for a finishing touch to match. That's why the choice of hardware available for all Polyframe systems offers the ultimate combination of quality, security and elegance.

Our hardware doesn't just look the part, it plays a major part in the security and performance of our windows and doors – including those products which contribute to a system that's PAS24 compliant, that's covered by the Secured by Design accreditation and conform to TS007: 2014 3-Star approval.



SECURITY

Our technologically advanced windows feature outstanding locking mechanisms engineered from high-strength materials and designed to protect your customers' homes if under forcible attack.

WINDOW SECURITY

All our windows are rigorously tested against attack and have additional upgrades available, including locking mechanisms with multiple locking points to achieve Secured by Design accreditation.

Secured by Design is a UK Police initiative aimed at setting heightened levels of security and testing to reduce burglary and crime. In order to achieve Secured by Design, windows and doors must include additional security features such as hinge guards and glass retention clips. And so, our windows and doors do.

As well as security testing, the window system has been tested to over 25,000 cycles which equates to over 25 years of use. They truly are made to last.

DOOR SECURITY

Having high-performance door security features is important for the safety of your customer's family, home and possessions.

Intelligently designed multi-point lock technology along with advanced gearbox technology gives complete peace of mind.

- 4 pre-compressed rollers allowing the door to seal prior to the hooks engaging for a smooth operation
- 2 steel hooks to maximise strength
- 2 anti-lift bolts preventing the door lock being dislodged from the keeps
- 1 centre hook latch for ease of day-to-day operation, with engaging dead bolts and locks for added security



bsi.
Enhanced Door
Security
KITEMARK™



KM 733369
BS 7412 / PAS 24

Please refer to the tables below for a quick reference guide as to what is on offer through Polyframe.

WINDOWS	Lock	Hinge/Friction Stay	Hinge Protector	Handle	 KM734056 BS8529/PAS24	 Police Preferred Specification
STANDARD SPECIFICATION	Yale Encloser Twin Cam	Yale Friction Stay	N/A	Era Connoisseur	No	No
UPGRADED SPECIFICATION	Yale Encloser Twin Cam Yale Central Locking Shootbolt	Yale Friction Stay	Yale Hinge Guards	Era Connoisseur	Yes	Yes
PREMIER UPGRADED SPECIFICATION	Era Extreme Shootbolt Locking	Yale Friction Stay	Yale Hinge Guards	Era Connoisseur	Yes	Yes

- HANDLE COLOURS**
- WHITE
 - BLACK
 - POLISHED GOLD
 - CHROME
 - SATIN (MILA HANDLE)

*Upgraded options are not available on Tilt & Turn windows.

DOORS	Lock	Cylinder	Hinge	Handle	 KM734056 BS8529/PAS24	 Police Preferred Specification
STANDARD SPECIFICATION	Yale Multi-Point	6 pin	Mila Pro Secure (SFS Option available)	Fab & Fix	No	No
UPGRADED SPECIFICATION	Yale Multi-Point	Yale 1* <i>With cylinder guard</i>	Mila Pro Secure (SFS Option available)	Fab & Fix	Yes	Yes
PREMIER UPGRADED SPECIFICATION	Yale Multi-Point	Yale 3* <i>Cylinder only</i>	Mila Pro Secure (SFS Option available)	Fab & Fix	Yes	Yes

- HANDLE COLOURS**
- WHITE
 - BLACK
 - POLISHED GOLD
 - CHROME
 - SATIN (MILA HANDLE)

*Upgraded options are not available on Patio doors.

Hardware & Locks

Lock



Yale Multi-Point

Cylinders



6 pin



Yale 1*



Yale 3*

Hinges



Mila Pro Secure



SFS

Door Handle



Fab & Fix

Window Handle



ERA Connoisseur

BUILDING REGULATIONS

Conserving energy (PART L)

We are proud to be a responsible manufacturer. That means we take changes in Regulations seriously – to ensure we're compliant, you're compliant and your customers enjoy products that meet the current standards.

Due to the changes to Part L and Part F of the Building Regulations in England introduced on the 15th June 2022, all projects are required to be on-spec for thermal efficiency, energy efficiency and ventilation capability.

Our Eurocell profiles are manufactured using the highest quality materials but it's important to understand how glazing can make a significant difference to how the completed window performs.

Simply visit polyframetrade.co.uk/trade/technical-downloads. It's also worth noting that the new Part L Regulations for New Build properties focus on 'U' values, whilst Renovation Properties will be assessed on Energy Ratings or 'U' Values.



POLYFRAME. UNCOMPROMISING QUALITY, SUPPORT AND CHOICE, WORTH TALKING ABOUT.

GUARANTEES

Polyframe, in conjunction with its raw material suppliers, guarantees its products for the following duration against:



All PVCu frames are guaranteed for **10 years** against defects relating to workmanship, delamination and discolouration, outside of normal wear and tear.



Sealed glass units are guaranteed for **10 years** against unit failure.

It should be noted that with all types of glass and all grades of energy rated glass, any form of condensation cannot be fully eliminated, but is generally greatly reduced.



Hardware is guaranteed for **10 years** for mechanical operation and against surface finish defects.

Where explicitly mentioned extended hardware guarantees are limited to the component suppliers guarantee – which is passed on to the customer. All claims against these extended guarantees are to be made directly with the component supplier, unless expressly stated otherwise by Polyframe.

Terms & Conditions apply. Please go to polyframetrade.co.uk/terms-conditions



Polyframe
Eurocell

Oldends
Oldend Hall,
Oldends Lane,
Stonehouse,
GL10 3RQ

01453 826884

polyframetrade.co.uk

The information provided in this publication is provided "as is" in August 2023. Polyframe may modify and change the information and specifications from time to time for a variety of reasons, without prior notice and updates will not be issued automatically. Due to the limitations of the processes of printing or digital display of colours, no liability can be accepted for the accuracy, they are intended as guidance only. This information is not intended to have any legal effect, whether by the way of advice, representation or warranty (express or implied). All rights reserved. Copyright in this publication belongs to Polyframe and all such copyright may not be used, sold, copied, or reproduced in whole or part in any manner in any media to any person without prior consent. Copyright © 2023 Polyframe. All rights reserved.

Part of the
 **Customade Group**

www.customade.co.uk